

# PPC-F H81 Series

**New**



## Intelligent Industrial Panel PC

- Support IEI iRIS-2400 IEI remote intelligent solution
- Scalable Intel® H81 chipset supports LGA1150 Intel® 4th generation Core™ i7/i5/i3, Pentium® or Celeron® processor with up to 65W TDP
- Robust IP65 aluminum front bezel
- Aesthetic ultra-thin bezel for seamless panel mount installation
- Projected capacitive multi-touch
- Dual full-size PCIe Mini card expansion
- AC/DC power input options (DC model by build to order manufacturing)



### Specifications

Model		PPC-F15A	PPC-F17A	PPC-F22A	PPC-F24A
LCD	LCD Display	15" (4:3)	17" (5:4)	21.5" (16:9)	24" (16:9)
	Max. Resolution	1024(W) x 768(H)	1280(W) x 1024(H)	1920(W) x 1080(H)	1920(W) x 1080(H)
	Brightness (cd/m <sup>2</sup> )	450	350	250	250
	Contrast Ratio	800 : 1	800 : 1	1000 : 1	3000 : 1
	LCD Color	16.2M	16.7M	16.7M	16.7M
	Pixel Pitch (mm)	0.297 x 0.297	0.26 x 0.26	0.25 x 0.25	0.28 x 0.28
	Viewing Angle (H-V)	160° / 150°	170° / 160°	170° / 160°	178° / 178°
	Backlight MTBF (hrs)	70000	50000	30000	30000
Motherboard	SBC Model	FPPCMB-H81-R10			
	CPU	LGA1150 Intel® 4th generation Core™ i7/i5/i3, Pentium® or Celeron® processor with up to 65W TDP			
	Chipset	Intel® H81			
	RAM	Support 2 x 204-pin 1066/1333/1600 MHz dual-channel DDR3 SO-DIMM slots (max. 16GB)			
Touch	Touchscreen & Controller	5-wire resistive type single touch window (Penmount 6000), 3H 2-point projected capacitive touch window (EETI EXC7200), 6H		2-point projected capacitive touch window (EETI EXC7200), 6H	2-point projected capacitive touch window (EETI EXC7200), 6H
		Input Interfaces	2 x RJ-45 LAN Port 2 x USB 3.0 4 x USB 2.0 1 x HDMI output 4 x RS-232 1 x RS-422/485 1 x MIC-in 1 x Line-out		1 x VGA output 1 x AC/DC power plug (DC model is by build to order manufacturing) 1 x AT/ATX switch 1 x Clear CMOS 1 x Reset button 1 x Power switch
Expansion			1 x Full-size PCIe Mini card 1 x Full-size PCIe Mini card co-lay mSATA (SATA2 only)		
Drive Bay		1 x 2.5" HDD/SSD drive bay		1 x 2.5" HDD/SSD drive bay or 1 x 3.5" HDD/SSD drive bay	
iRIS Remote Management Solution		iRIS-2400 (optional)			
Physical	Construction Material	Aluminum front cover and sheet metal rear cover			
	Mounting	Panel mount, rack mount, 100x100 VESA mount		Panel mount, 100x100 VESA mount	
	Enclosure Color	Black C			
	Dimensions (mm)	303 x 378.5 x 65.7	341.4 x 408.4 x 73.8	350.4 x 550.4 x 71.7	382 x 600 x 71.7
	Cutout Dimensions (mm)	285.6 x 361.1	323 x 390	341 x 536	359.6 x 577.6
	Net/ Gross Weight (kg)	5.6/ 8.3	7.5/10.7	10.1/14.4	10.5/14.8
Environment	Operating Temperature (with air flow)	-10°C ~ 50°C			
	Storage Temperature	-20°C ~ 60°C			
	Humidity	10% to 95% (non-condensing)			
	IP Level	Front IP 65			
	Safety and EMC	CE & FCC certified			
Power Supply	AC Input	AC input ATX power supply - P/N: ACE-A662B-RS-10 - 220W power supply - Input: 90VAC-264VAC, 50/60Hz - Output (max.): 3.3V@14A, 5V@16A, 12V1@16A, 12V2@10A, -12V@0.8A			
	DC Input (produced by order)	DC input ATX power supply - P/N: ACE-4520C-RS - 200W power supply - Input: 24VDC, 15A (max) - Output (max.): 3.3V@12A, 5V@12A, 12V@15.4A, -12V@0.5A			
Power Consumption	80W	100W	110W	120W	

## Ordering Information

Part Number	Description	
15"	PPC-F15AA-H81i-P/4G/R-R20	15" 400 cd/m <sup>2</sup> XGA Panel PC with Intel® H81 chipset, Intel® Pentium® Processor G3420 (3M Cache, 3.20 GHz), TDP 53W, 2GB RAM*2, support iRIS-2400, black color, PSU ACE-A622B, resistive touch window, R20
	PPC-F15AA-H81i-i3/4G/R-R20	15" 400 cd/m <sup>2</sup> XGA Panel PC with Intel® H81 chipset, Core i3 Dual Core i3-4330 Processor (4M Cache, 3.50 GHz), TDP 54W, 2GB RAM*2, support iRIS-2400, black color, PSU ACE-A622B, resistive touch window, R20
	PPC-F15AA-H81i-i5/4G/R-R20	15" 400 cd/m <sup>2</sup> XGA Panel PC with Intel® H81 chipset, Core i5 Quad Core i5-4570S Processor (6M Cache, up to 3.60 GHz), TDP 65W, 2GB RAM*2, support iRIS-2400, black color, PSU ACE-A622B, resistive touch window, R20
	PPC-F15AA-H81i-P/4G/PC-R20	15" 400 cd/m <sup>2</sup> XGA Panel PC with Intel® H81 chipset, Intel® Pentium® Processor G3420 (3M Cache, 3.20 GHz), TDP 53W, 2GB RAM*2, support iRIS-2400, black color, PSU ACE-A622B, projective capacitive touch window, R20
	PPC-F15AA-H81i-i3/4G/PC-R20	15" 400 cd/m <sup>2</sup> XGA Panel PC with Intel® H81 chipset, Core i3 Dual Core i3-4330 Processor (4M Cache, 3.50 GHz), TDP 54W, 2GB RAM*2, support iRIS-2400, black color, PSU ACE-A622B, projective capacitive touch window, R20
	PPC-F15AA-H81i-i5/4G/PC-R20	15" 400 cd/m <sup>2</sup> XGA Panel PC with Intel® H81 chipset, Core i5 Quad Core i5-4570S Processor (6M Cache, up to 3.60 GHz), TDP 65W, 2GB RAM*2, support iRIS-2400, black color, PSU ACE-A622B, projective capacitive touch window, R20
17"	PPC-F17AA-H81i-P/4G/R-R11	17" 350 cd/m <sup>2</sup> SXGA Panel PC with Intel® H81 chipset, Intel® Pentium® Processor G3420 (3M Cache, 3.20 GHz), TDP 53W, 2GB RAM*2, support iRIS-2400, black color, PSU ACE-A622B, resistive touch window, R11
	PPC-F17AA-H81i-i3/4G/R-R11	17" 350 cd/m <sup>2</sup> SXGA Panel PC with Intel® H81 chipset, Core i3 Dual Core i3-4330 Processor (4M Cache, 3.50 GHz), TDP 54W, 2GB RAM*2, support iRIS-2400, black color, PSU ACE-A622B, resistive touch window, R11
	PPC-F17AA-H81i-i5/4G/R-R11	17" 350 cd/m <sup>2</sup> SXGA Panel PC with Intel® H81 chipset, Core i5 Quad Core i5-4570S Processor (6M Cache, up to 3.60 GHz), TDP 65W, 2GB RAM*2, support iRIS-2400, black color, PSU ACE-A622B, resistive touch window, R11
	PPC-F17AA-H81i-P/4G/PC-R11	17" 350 cd/m <sup>2</sup> SXGA Panel PC with Intel® H81 chipset, Intel® Pentium® Processor G3420 (3M Cache, 3.20 GHz), TDP 53W, 2GB RAM*2, support iRIS-2400, black color, PSU ACE-A622B, projective capacitive touch window, R11
	PPC-F17AA-H81i-i3/4G/PC-R11	17" 350 cd/m <sup>2</sup> SXGA Panel PC with Intel® H81 chipset, Core i3 Dual Core i3-4330 Processor (4M Cache, 3.50 GHz), TDP 54W, 2GB RAM*2, support iRIS-2400, black color, PSU ACE-A622B, projective capacitive touch window, R11
	PPC-F17AA-H81i-i5/4G/PC-R11	17" 350 cd/m <sup>2</sup> SXGA Panel PC with Intel® H81 chipset, Core i5 Quad Core i5-4570S Processor (6M Cache, up to 3.60 GHz), TDP 65W, 2GB RAM*2, support iRIS-2400, black color, PSU ACE-A622B, projective capacitive touch window, R11
21.5"	PPC-F22AA-H81i-P/4G/PC-R11	21.5" 250 cd/m <sup>2</sup> FHD Panel PC with Intel H81 chipset, Intel® Pentium® Processor G3420 (3M Cache, 3.20 GHz), TDP 53W, 2GB RAM*2, support iRIS-2400, black color, PSU ACE-A622B, projective capacitive touch window, R11
	PPC-F22AA-H81i-i3/4G/PC-R11	21.5" 250 cd/m <sup>2</sup> FHD Panel PC with Intel H81 chipset, Core i3 Dual Core i3-4330 Processor (4M Cache, 3.50 GHz), TDP 54W, 2GB RAM*2, support iRIS-2400, black color, PSU ACE-A622B, projective capacitive touch window, R11
	PPC-F22AA-H81i-i5/4G/PC-R11	21.5" 250 cd/m <sup>2</sup> FHD Panel PC with Intel H81 chipset, Core i5 Quad Core i5-4570S Processor (6M Cache, up to 3.60 GHz), TDP 65W, 2GB RAM*2, support iRIS-2400, black color, PSU ACE-A622B, projective capacitive touch window, R11
24"	PPC-F24AA-H81i-P/4G/PC-R11	24" 250 cd/m <sup>2</sup> FHD Panel PC with Intel H81 chipset, Intel® Pentium® Processor G3420 (3M Cache, 3.20 GHz), TDP 53W, 2GB RAM*2, support iRIS-2400, black color, PSU ACE-A622B, projective capacitive touch window, R11
	PPC-F24AA-H81i-i3/4G/PC-R11	24" 250 cd/m <sup>2</sup> FHD Panel PC with Intel H81 chipset, Core i3 Dual Core i3-4330 Processor (4M Cache, 3.50 GHz), TDP 54W, 2GB RAM*2, support iRIS-2400, black color, PSU ACE-A622B, projective capacitive touch window, R11
	PPC-F24AA-H81i-i5/4G/PC-R11	24" 250 cd/m <sup>2</sup> FHD Panel PC with Intel H81 chipset, Core i5 Quad Core i5-4570S Processor (6M Cache, up to 3.60 GHz), TDP 65W, 2GB RAM*2, support iRIS-2400, black color, PSU ACE-A622B, projective capacitive touch window, R11

\* DC power supply SKU is available with particular purchase, please contact sales team.

## Options

Item	PPC-F15A	PPC-F17A	PPC-F22A	PPC-F24A
Arm	ARM-31-RS	ARM-31-RS	ARM-31-RS	ARM-31-RS
Stand	STAND-A21 STAND-A19-RS STAND-C19-R10	STAND-C19-R10 STAND-A21-R10	STAND-C19-R10 STAND-A21-R10	STAND-C19-R10 STAND-A21-R10
Wall Mount Kit	WK-190MS-R10			
Panel Mount Kit	FPK-04-R10		FPK-05-R10	FPK-06-R10
Rack Mount Kit	FRK15-R10	FRK17-R10	N/A	
Wi-Fi Kit	PPC-WL-KIT03-R11			
iRIS (IEI Remote Intelligent System) Kit	iRIS-2400-R10			

## Packing List

Item	Q'ty	Remark
Driver CD	1	
One Key Recovery CD	1	
Power Cord	1	Depends on shipping region
Screw Kit	1	
Touch Pen	1	Resistive touch only

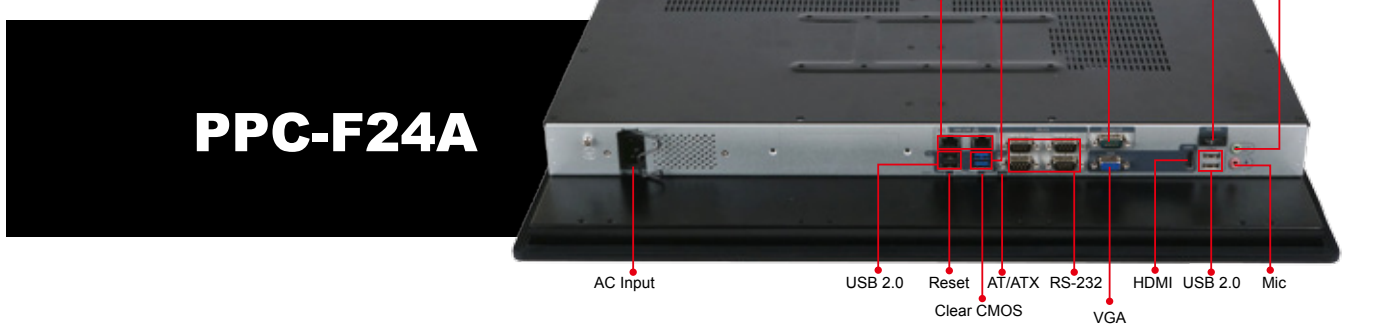
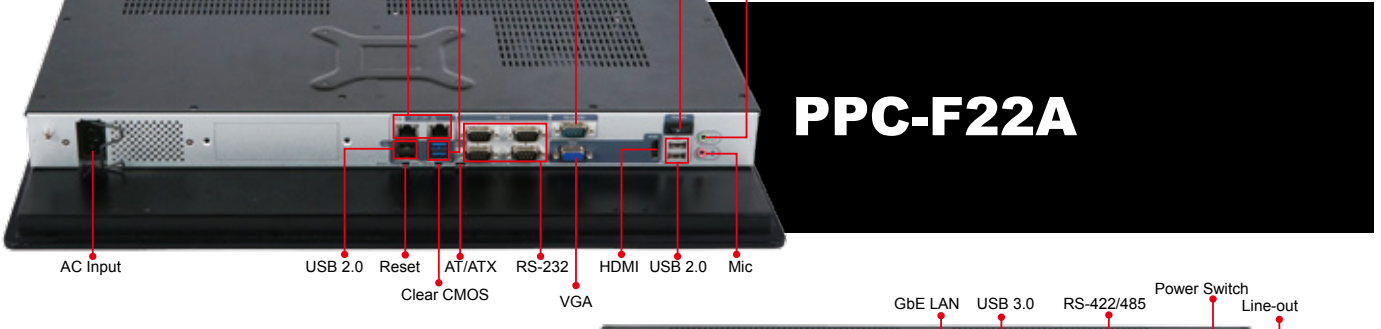
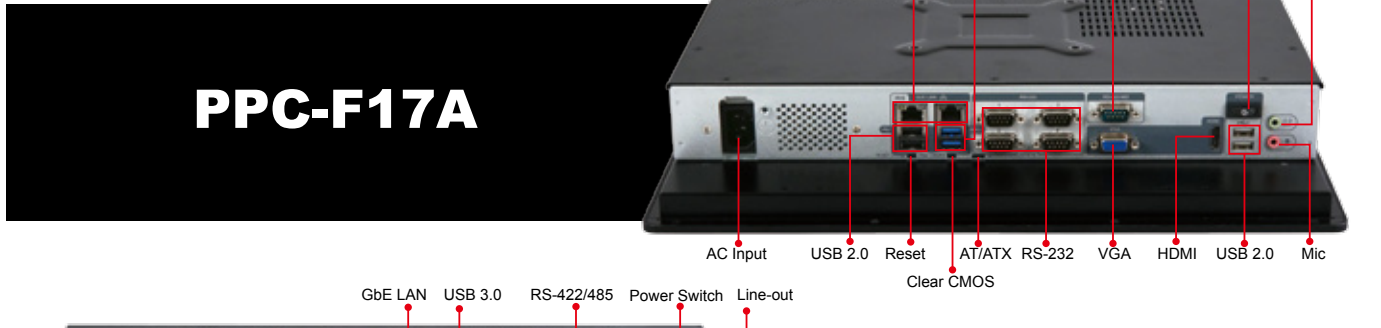
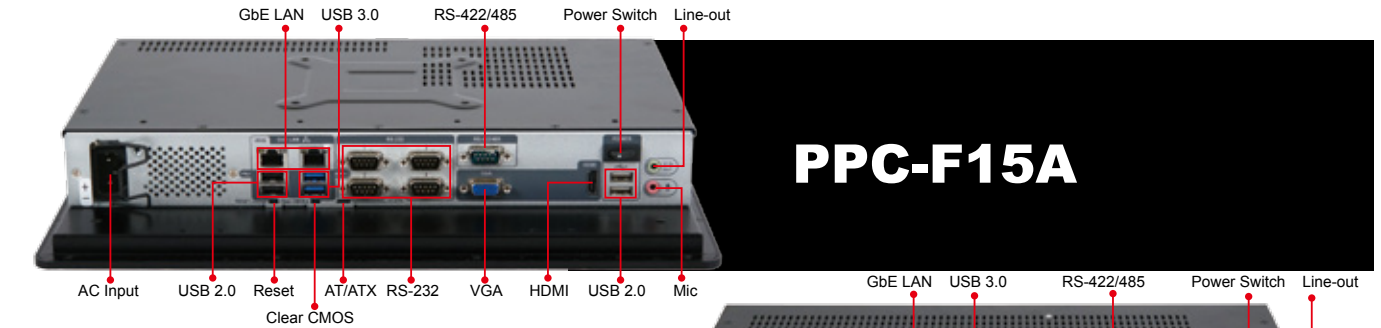

**PPC-F15A Dimensions**

(Unit: mm)

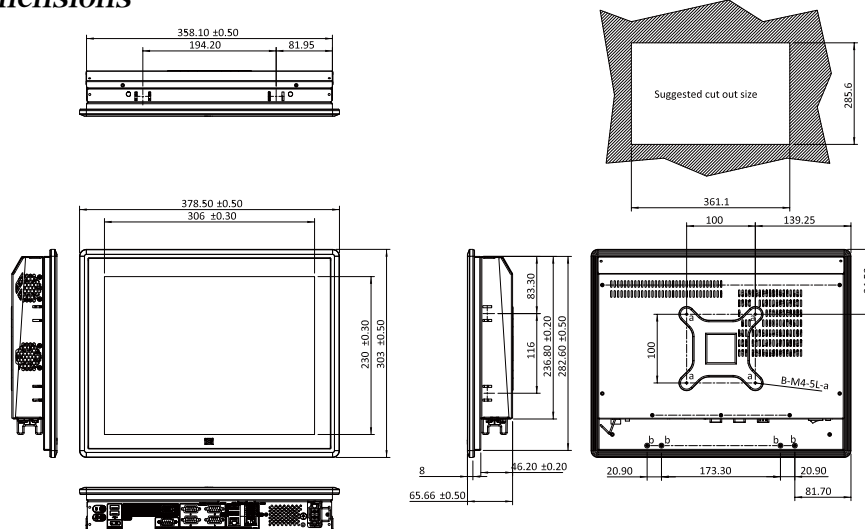

**PPC-F17A Dimensions**

(Unit: mm)

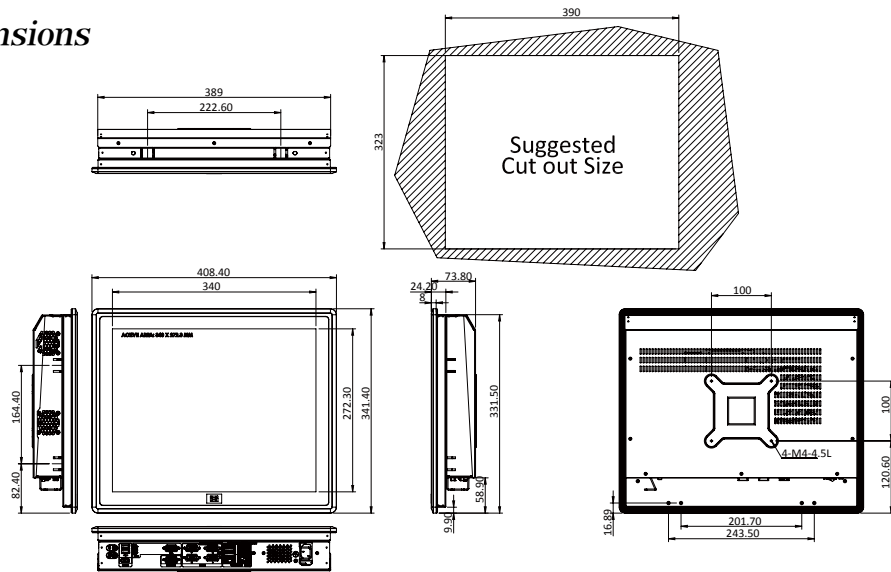

**PPC-F22A Dimensions**

(Unit: mm)

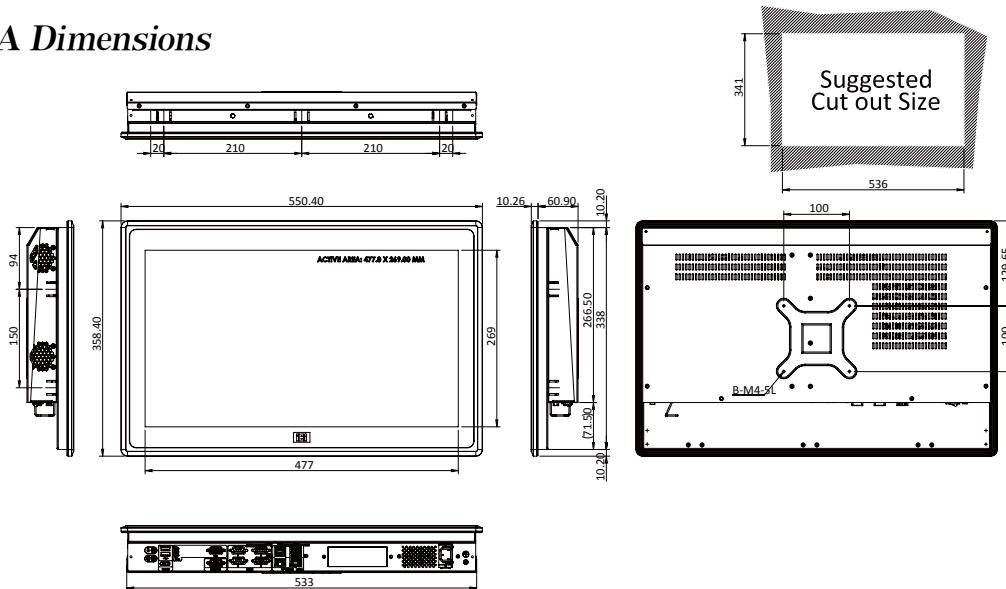

**PPC-F24A Dimensions**

(Unit: mm)

